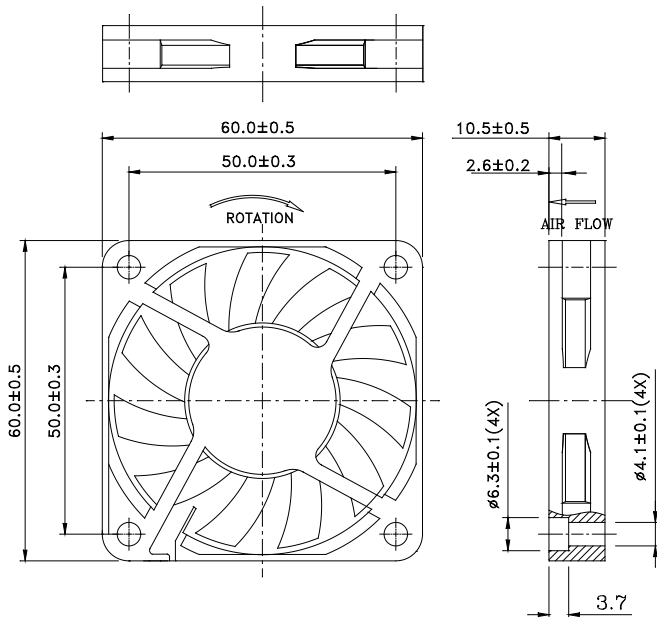
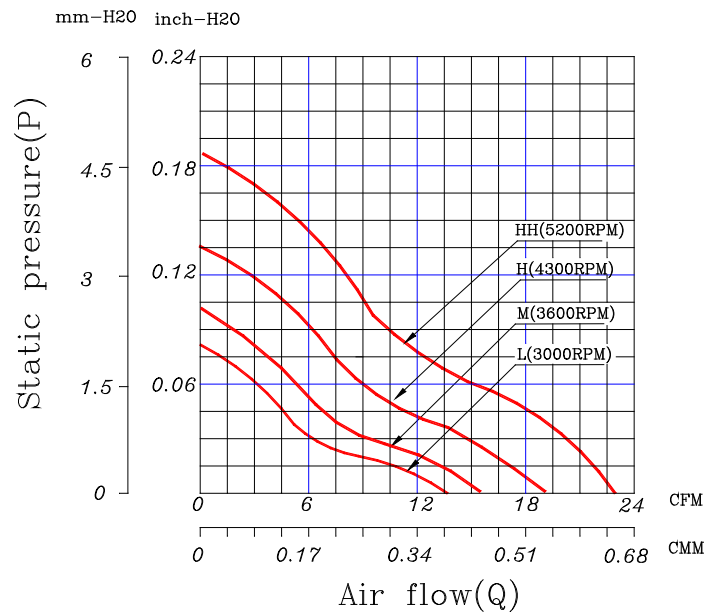

60 x 60 x 10 mm Series
Rev II-22Ø 12/24VDC
Dimensions

Performance Curves

Air exhaust over struts. Rotational direction CCW looking at rotor

Brushless DC Motor	Bearing Type
Housing: PBT 94V0	● CeraDyna A
Impeller: PBT 94V0	● 2-Ball
Weight: 50 g	● 1-Ball-1-Sleeve
Impedance protected	● Sleeve
Lead wire UL 1007 AWG 26	* Please contact us for CeraDyna-C availability.

Function options	
● Frequency Generator	● Auto Restart
● Temperature Control	● Rotation Detection

* Please contact us for PWM function availability.

 * **Safety Approval: CE, UL, TUV**

* All fans are with electronic protection against reverse polarity. The fan only operates when the polarity is correct.

Specifications

Model	Rated Voltage (VDC)	Rated Current (Amp)	Input Power (Watts)	Nominal Speed (RPM)	Airflow (CFM)	Static Pressure (inch-H ₂ O)	Noise Level (dBA)
FD1260-A01XXA	12	0.33	3.96	5200	23.70	0.18	38.00
FD1260-A11XXA	12	0.25	3.00	4300	19.60	0.13	30.00
FD1260-A21XXA	12	0.18	2.16	3600	16.41	0.10	27.00
FD1260-A31XXA	12	0.11	1.32	3000	13.67	0.08	23.00
FD2460-A01XXA	24	0.17	4.08	5200	23.70	0.18	38.00
FD2460-A11XXA	24	0.13	3.12	4300	19.60	0.13	30.00
FD2460-A21XXA	24	0.10	2.40	3600	16.41	0.10	27.00
FD2460-A31XXA	24	0.07	1.68	3000	13.67	0.08	23.00

* All readings are typical value at rated voltage.

 * Please refer to **PART NUMBER SYSTEM** for bearing type and part number "XX" designation.

* Specifications are subject to change without prior notice.

* Please specify revision number when ordering.